

MIMD-PA-0727-01

700-960MHz 5dBi/1700-2700MHz 9dBi PANEL MIMD ANTENNA X2+RG58(40CM)+N FEMALE X2

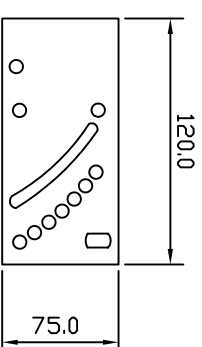

⊙ X4
WASHER
⊗ X4
NUT

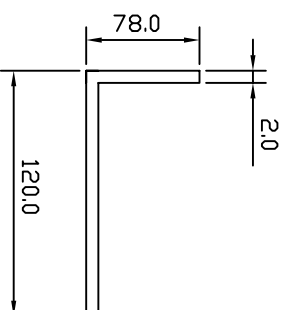
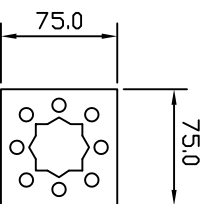
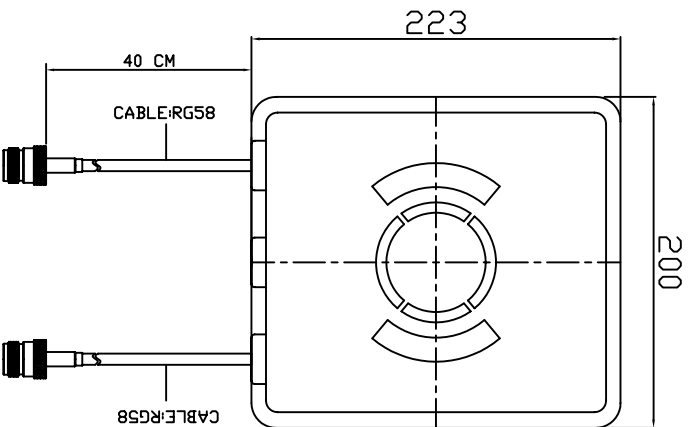
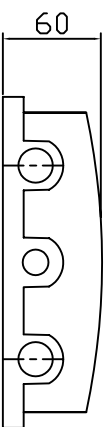
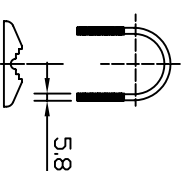
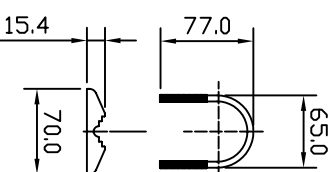

ANTENNA CONNECTOR : N FEMALE X2

1 FREQUENCY RANGE : 700-960/1700-2700MHz

2 GAIN : 700-960MHz 5dBi/1700-2700MHz 9dBi

3 VSWR : <=2.5 : 1

4 IMPEDANCE : 50 Ω

5 POLARIZATION : LINEAR VERTICAL

6 Antenna Connector : N FEMALE x2

7 Maximum Power : 100W

8 Dimensions : L223XW200XH60mm

9

10

11

12

13